



# WL27-3P3402S17

RAY26 Reflex Array

PHOTOELECTRIC SENSORS

**SICK**  
Sensor Intelligence.



Illustration may differ

### Ordering information

Type	part no.
WL27-3P3402S17	1051529

Other models and accessories → [www.sick.com/RAY26\\_Reflex\\_Array](http://www.sick.com/RAY26_Reflex_Array)

### Detailed technical data

#### Features

<b>Functional principle</b>	Photoelectric retro-reflective sensor
<b>Dimensions (W x H x D)</b>	24.6 mm x 80 mm x 54.2 mm
<b>Housing design (light emission)</b>	Rectangular
<b>Minimum object size</b>	5 mm, position-independent detection within the light array
<b>Sensing range max.</b>	0 m ... 1.5 m <sup>1)</sup>
<b>Sensing range</b>	0 m ... 1.5 m <sup>1)</sup>
<b>Distance of the sensor to reflector</b>	0.5 m ... 1.5 m <sup>1)</sup>
<b>Type of light</b>	Visible red light
<b>Light source</b>	PinPoint LED <sup>2)</sup>
<b>Adjustment</b>	Single teach-in button
<b>AutoAdapt</b>	✓
<b>Special feature</b>	Light band
<b>Special applications</b>	Detecting transparent objects, Detecting perforated objects, Detecting uneven, shiny objects, Detecting objects with position tolerances
<b>Special features</b>	Detection height 24 mm

<sup>1)</sup> Reflector PL40A.

<sup>2)</sup> Average service life: 100,000 h at T<sub>U</sub> = +25 °C.

## Mechanics/electronics

<b>Supply voltage <math>U_B</math></b>	10 V DC ... 30 V DC <sup>1)</sup>
<b>Ripple</b>	< 5 V <sub>pp</sub> <sup>2)</sup>
<b>Current consumption</b>	35 mA <sup>3)</sup>
<b>Switching output</b>	PNP
<b>Output function</b>	Complementary
<b>Switching mode</b>	Light/dark switching
<b>Signal voltage PNP HIGH/LOW</b>	Approx. $V_S - 2.5 \text{ V} / 0 \text{ V}$
<b>Output current <math>I_{\max}</math></b>	≤ 100 mA
<b>Response time</b>	≤ 2.5 ms <sup>4)</sup>
<b>Switching frequency</b>	200 Hz <sup>5)</sup>
<b>Connection type</b>	Cable with M12 male connector, 4-pin, 270 mm <sup>6)</sup>
<b>Cable material</b>	Plastic, PVC
<b>Circuit protection</b>	A <sup>7)</sup> B <sup>8)</sup> C <sup>9)</sup>
<b>Protection class</b>	II <sup>10)</sup>
<b>Weight</b>	130 g
<b>Housing material</b>	Plastic, ABS
<b>Optics material</b>	Plastic, PMMA
<b>Enclosure rating</b>	IP67
<b>Special feature</b>	Light band
<b>Ambient operating temperature</b>	-30 °C ... +60 °C <sup>11)</sup>
<b>Ambient temperature, storage</b>	-40 °C ... +75 °C
<b>UL File No.</b>	NRKH.E181493 & NRKH7.E181493

<sup>1)</sup> Limit values when operated in short-circuit protected network: max. 8 A.

<sup>2)</sup> May not fall below or exceed  $U_V$  tolerances.

<sup>3)</sup> Without load.

<sup>4)</sup> Signal transit time with resistive load.

<sup>5)</sup> With light/dark ratio 1:1.

<sup>6)</sup> Do not bend below 0 °C.

<sup>7)</sup> A =  $V_S$  connections reverse-polarity protected.

<sup>8)</sup> B = inputs and output reverse-polarity protected.

<sup>9)</sup> C = interference suppression.

<sup>10)</sup> Reference voltage: 50 V DC.

<sup>11)</sup> Avoid condensation on the front screen of the sensor and on the reflector.

## Safety-related parameters

<b>MTTF<sub>D</sub></b>	976 years
<b>DC<sub>avg</sub></b>	0 %

## Classifications

<b>ECLASS 5.0</b>	27270902
<b>ECLASS 5.1.4</b>	27270902
<b>ECLASS 6.0</b>	27270902

<b>ECLASS 6.2</b>	27270902
<b>ECLASS 7.0</b>	27270902
<b>ECLASS 8.0</b>	27270902
<b>ECLASS 8.1</b>	27270902
<b>ECLASS 9.0</b>	27270902
<b>ECLASS 10.0</b>	27270902
<b>ECLASS 11.0</b>	27270902
<b>ECLASS 12.0</b>	27270902
<b>ETIM 5.0</b>	EC002717
<b>ETIM 6.0</b>	EC002717
<b>ETIM 7.0</b>	EC002717
<b>ETIM 8.0</b>	EC002717
<b>UNSPSC 16.0901</b>	39121528

### Adjustments

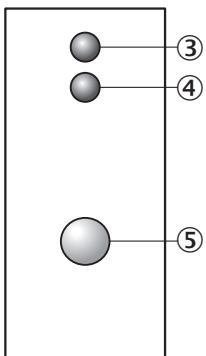

- ③ LED indicator green: Supply voltage active
- ④ LED indicator yellow: Status of received light beam
- ⑤ Sensitivity setting: single teach-in button

### Connection type

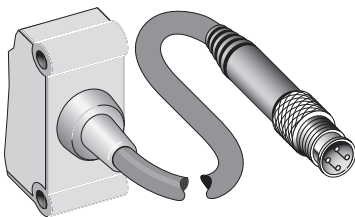

Connection diagram Cd-083

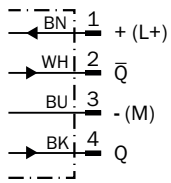

Dimensional drawing WL27-3P3402S17

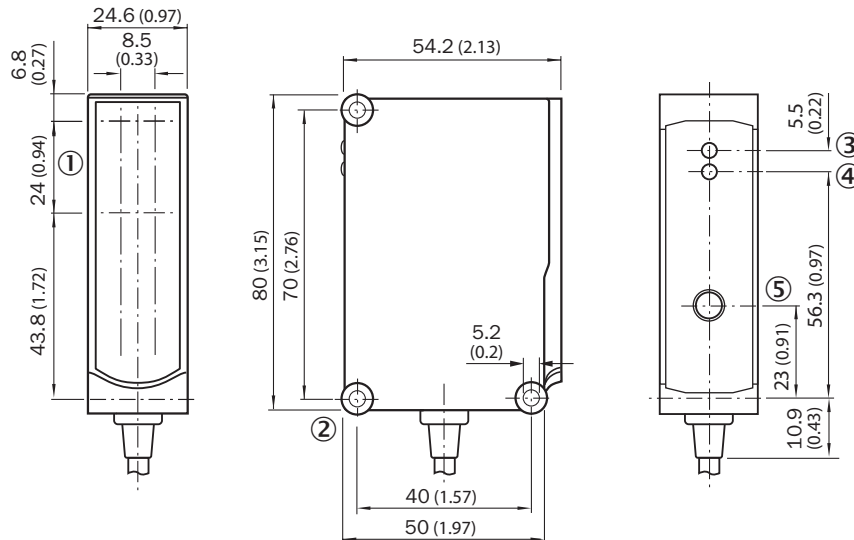







Dimensions in mm (inch)

- ① Opening of light band
- ② Mounting hole  $\varnothing$  5.2 mm
- ③ LED indicator green: Supply voltage active
- ④ LED indicator yellow: Status of received light beam
- ⑤ Sensitivity setting: single teach-in button

### Recommended accessories

Other models and accessories → [www.sick.com/RAY26\\_Reflex\\_Array](http://www.sick.com/RAY26_Reflex_Array)

	Brief description	Type	part no.
<b>Mounting systems</b>			
	<ul style="list-style-type: none"> <li><b>Description:</b> Universal mounting bracket for reflectors</li> <li><b>Dimensions (W x H x L):</b> 85 mm x 90 mm x 35 mm</li> <li><b>Material:</b> Steel</li> <li><b>Details:</b> Steel, zinc coated</li> <li><b>Suitable for:</b> C110A, P250, PL20, PL30A, PL40A, PL80A</li> </ul>	BEF-WN-REFX	2064574
	<ul style="list-style-type: none"> <li><b>Description:</b> Plate N11N for universal clamp bracket</li> <li><b>Material:</b> Stainless steel</li> <li><b>Details:</b> Stainless steel 1.4571 (sheet), Stainless steel 1.4408 (clamp)</li> <li><b>Items supplied:</b> Universal clamp (5322627), mounting hardware</li> <li><b>Usable for:</b> DeltaPac, Glare, WTD20E</li> </ul>	BEF-KHS-N11N	2071081
<b>reflectors and optics</b>			
	<ul style="list-style-type: none"> <li><b>Description:</b> Rectangular, screw connection</li> <li><b>Dimensions:</b> 84 mm 84 mm</li> <li><b>Ambient operating temperature:</b> -30 °C ... +65 °C</li> </ul>	PL80A	1003865
<b>connectors and cables</b>			
	<ul style="list-style-type: none"> <li><b>Connection type head A:</b> Female connector, M12, 4-pin, straight, A-coded</li> <li><b>Connection type head B:</b> Flying leads</li> <li><b>Signal type:</b> Sensor/actuator cable</li> <li><b>Cable:</b> 5 m, 4-wire, PUR, halogen-free</li> <li><b>Description:</b> Sensor/actuator cable, unshielded</li> <li><b>Application:</b> Drag chain operation, Zones with oils and lubricants, Robot, Drag chain operation</li> </ul>	YF2A14-050UB3XLEAX	2095608
	<ul style="list-style-type: none"> <li><b>Connection type head A:</b> Female connector, M12, 4-pin, straight, A-coded</li> <li><b>Connection type head B:</b> Flying leads</li> <li><b>Signal type:</b> Sensor/actuator cable</li> <li><b>Cable:</b> 5 m, 4-wire, PVC</li> <li><b>Description:</b> Sensor/actuator cable, unshielded</li> <li><b>Application:</b> Uncontaminated zones, Zones with chemicals</li> </ul>	YF2A14-050VB3XLEAX	2096235
	<ul style="list-style-type: none"> <li><b>Connection type head A:</b> Male connector, M12, 4-pin, straight, A-coded</li> <li><b>Description:</b> Unshielded</li> <li><b>Connection systems:</b> Screw-type terminals</li> <li><b>Permitted cross-section:</b> ≤ 0.75 mm<sup>2</sup></li> </ul>	STE-1204-G	6009932

## SICK AT A GLANCE

SICK is one of the leading manufacturers of intelligent sensors and sensor solutions for industrial applications. A unique range of products and services creates the perfect basis for controlling processes securely and efficiently, protecting individuals from accidents and preventing damage to the environment.

We have extensive experience in a wide range of industries and understand their processes and requirements. With intelligent sensors, we can deliver exactly what our customers need. In application centers in Europe, Asia and North America, system solutions are tested and optimized in accordance with customer specifications. All this makes us a reliable supplier and development partner.

Comprehensive services complete our offering: SICK LifeTime Services provide support throughout the machine life cycle and ensure safety and productivity.

For us, that is “Sensor Intelligence.”

## WORLDWIDE PRESENCE:

Contacts and other locations –[www.sick.com](http://www.sick.com)