



### Model number

INY060D-F99-2I2E2-V17

### Features

- Analog output 4 mA ... 20 mA
- Fixed evaluation limits
- High shock resistance
- Increased noise immunity 100 V/m
- Measuring range -30° ... +30°

### Electrical connection

Standard symbol/Connection:

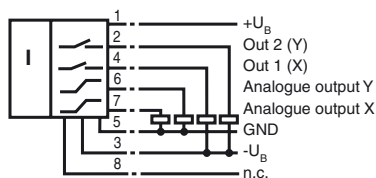

## Technical Data

### General specifications

Type	Inclination sensor, 2-axis
Measurement range	-30 ... 30 °
Absolute accuracy	≤ ± 0.2 °
Response delay	≤ 25 ms
Resolution	≤ 0.02 °
Repeat accuracy	≤ ± 0.04 °
Temperature influence	≤ 0.004 °/K

### Functional safety related parameters

MTTF <sub>d</sub>	304 a
Mission Time (T <sub>M</sub> )	20 a
Diagnostic Coverage (DC)	0 %

### Indicators/operating means

Operation indicator	LED, green
Switching state	2 yellow LEDs: Switching status (each output)

### Electrical specifications

Operating voltage U <sub>B</sub>	10 ... 30 V DC
No-load supply current I <sub>0</sub>	≤ 25 mA
Time delay before availability t <sub>v</sub>	≤ 200 ms

### Switching output

Output type	2 switch outputs PNP, NO, reverse polarity protected, short-circuit protected
Operating current I <sub>L</sub>	≤ 100 mA
Voltage drop	≤ 3 V

### Analog output

Output type	2 current outputs 4 ... 20 mA (one output for each axis)
Load resistor	0 ... 200 Ω at U <sub>B</sub> = 10 ... 18 V 0 ... 500 Ω at U <sub>B</sub> = 18 ... 30 V

### Ambient conditions

Ambient temperature	-40 ... 85 °C (-40 ... 185 °F)
Storage temperature	-40 ... 85 °C (-40 ... 185 °F)

### Mechanical specifications

Connection type	8-pin, M12 x 1 connector
Housing material	PA
Degree of protection	IP68 / IP69K
Mass	240 g

### Factory settings

Analog output (X)	-30 ° ... 30 °
Analog output (Y)	-30 ° ... 30 °
Switching output (X)	-30 ° ... 30 °
Switching output (Y)	-30 ° ... 30 °

### Compliance with standards and directives

Standard conformity	
Shock and impact resistance	100 g according to DIN EN 60068-2-27
Standards	EN 60947-5-2:2007 IEC 60947-5-2:2007

### Approvals and certificates

CSA approval	cCSAus Listed, General Purpose, Class 2 Power Source
--------------	------------------------------------------------------

**Dimensions**

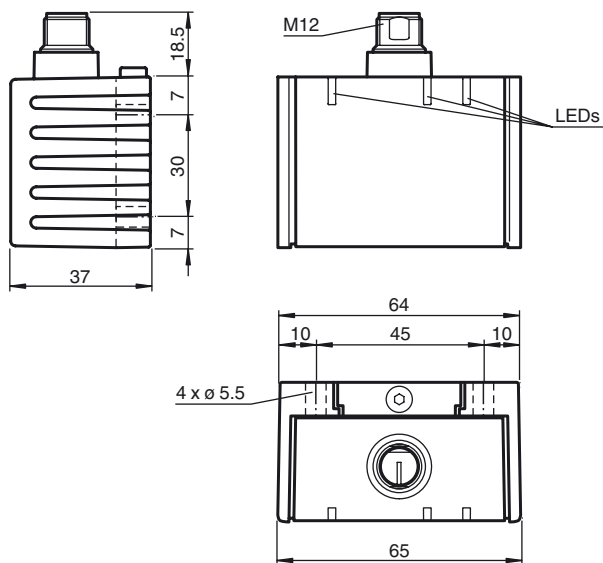

**Pinout**

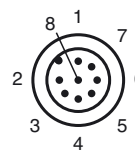

Wire colors

1	WH	(white)
2	BN	(brown)
3	GN	(green)
4	YE	(yellow)
5	GY	(gray)
6	PK	(pink)
7	BU	(blue)
8	RD	(red)

**Accessories**

**V17-G-2M-PUR**

Female cordset, M12, 8-pin, shielded, PUR cable

**V17-G-5M-PUR**

Female cordset, M12, 8-pin, shielded, PUR cable

**V17-G-10M-PUR**

Female cordset, M12, 8-pin, shielded, PUR cable

**V17-G-10M-PVC-ABG**

Female cordset, M12, 8-pin, shielded, PVC cable

**Sensor Orientation**

In the default setting the zero position of the sensor is reached, when the sensor is mounted on a horizontal plane and electrical connection faces sideways.

**X Orientation**

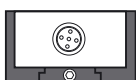

X = 0°

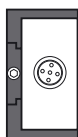

X = 90°

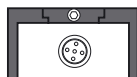

X = ±180°

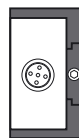

X = 270° (-90°)

**Y Orientation**

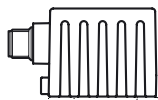

Y = 0°

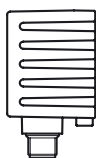

Y = 90°

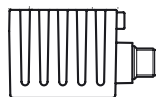

Y = ±180°



Y = 270° (-90°)

**Mounting of the sensor**

Sensors from the -F99 series consist of a sensor module and accompanying cast aluminum housing. Select a horizontal flat surface with minimum dimensions of 70 mm x 50 mm to mount the sensor. Mount the sensor as follows:



1. Loosen the central screw under the sensor connection.
  2. Slide back the clamping element until you are able to remove the sensor module from the housing.
  3. Remove the sensor module from the housing
  4. Position the housing at the required mounting location and secure using four countersunk screws. Make sure that the heads of the screws do not protrude.
  5. Place the sensor module in the housing.
  6. Slide the clamping element flush into the housing. Check that the sensor element is seated correctly.
  7. Finally tighten the central screw.
- The sensor is now mounted correctly.