

Type H8C Load Cell



Short description



- Nickel plated alloy steel IP67 shear beam load cell (100 kg, 250kg are bending beam load cells)
- Adhesive sealed
- Suitable platform weighing, bed weighing, etc.
- High accuracy
- High reliability
- Current calibrated (sc-option)

 test certificate no. TC8012 Revision 1
C of C no R60/2000-NL1-12.12

 Certificate no. 12-028

Available models

Capacity	Accuracy	Full article description
100kg	C3/C4/C5	H8C-C3/C4/C5-100kg-4B(-SC-W6)
250kg	C3/C4/C5	H8C-C3/C4/C5-250kg-4B(-SC-W6)
500kg	C3/C4/C5	H8C-C3/C4/C5-500kg-4B(-SC-W6)
750kg	C3/C4/C5	H8C-C3/C4/C5-750kg-4B(-SC-W6)
1t	C3/C4/C5	H8C-C3/C4/C5-1.0t-4B(-SC-W6)
1.5t	C3/C4/C5	H8C-C3/C4/C5-1.5t-4B(-SC-W6)
2t	C3/C4/C5	H8C-C3/C4/C5-2.0t-4B(-SC-W6)
2.5t	C3/C4/C5	H8C-C3/C4/C5-2.5t-6B(-SC-W6)
3t	C3/C4/C5	H8C-C3/C4/C5-3.0t-6B(-SC-W6)
5t	C3/C4/C5	H8C-C3/C4/C5-5.0t-6B(-SC-W6)
10t	C3/C4/C5	H8C-C3/C4/C5-10t-6B(-SC-W6)

Specifications and dimensions are subject to change without notice and do not constitute any liability whatsoever.

Type H8C Load Cell

Detailed specifications H8C

Accuracy class		OIML R60 C3	OIML R60 C4	OIML R60 C5	
Output sensitivity (= FS)	mV/V	3.0 ± 0.003			
Maximum capacity (E _{max})	t	0.1, 0.25, 0.5, 0.75, 1, 1.5, 2, 2.5, 3, 5, 10		0.1, 0.25, 0.5, 0.75, 1, 1.5,	3, 5, 10
Max.number of load cell intervals	n _{LC}	3000	4000	5000	
Ratio of min. LC verification interval	Y = E _{max} / v _{min}	10000	15000	20000	18000
Combined Error	%FS	≤± 0.023	≤± 0.0175	≤± 0.014	
Minimum dead load	Of E _{max}	0%			
Safe overload	of E _{max}	150 %			
Ultimate overload	of E _{max}	300 %			
Zero balance	of FS	< ± 1.0 %			
Excitation, recommended voltage	V	5 ~ 12			
Excitation maximum	V	18			
Input resistance	Ω	350 ± 3.5			
Output resistance	Ω	350 ± 3.5			
Insulation resistance	MΩ	≥5000 (at 50VDC)			
Compensated temperature	°C	-10 ~+40			
Operating temperature	°C	-35 ~ +65			
Storage temperature	°C	-40 ~ +80			
Element material		Nickel plated alloy steel			
Ingress Protection (acc. to EN 60529)		IP67			
Recommended torque on fixation	Nm	M12: 75	M18:500	M24:750	
ATEX classification (optional)		II1G Ex ia II1C T4	II1D Ex iaD 20 T73°C	II3G nL IIC T4	

Wiring

Wiring:

Shielded, 4 or 6 conductor cable

Cable diameter: Ø5mm.

Standard cable length for 100kg – 2t: 4m and 6m for the higher capacities.

Shield not connected to element.

4-wire diagram

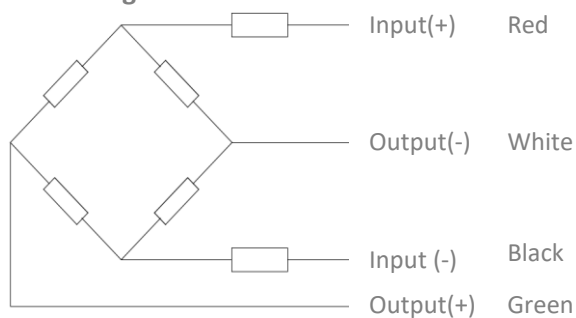

6-wire diagram

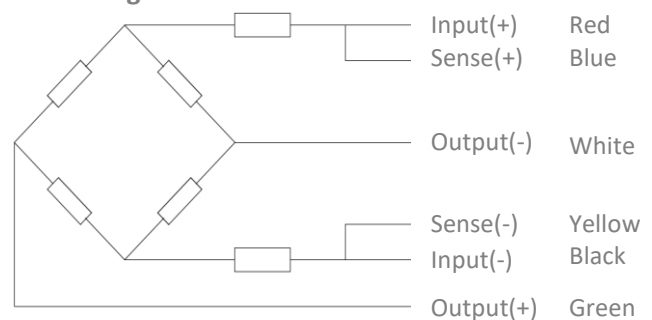

Specifications and dimensions are subject to change without notice and do not constitute any liability whatsoever.

Type H8C Load Cell

Ordering Info:

H8C - C3 - 1.0t - 4 - - BX - SC - XX

- Option XX. No mark is standard version, W4 is through loading hole, W6 is "T" end loading hole.
- Option SC (standard current).
- Cable option. No mark is 4 conductor cable and with a "6" a 6 conductor cable.
- Thread option. No mark is Metric Thread and "Y" is Imperial thread.
- Length of the cable in meters.
- Nominal capacity (E_{max}) for Metric in t(on) and Imperial in lbs up to 500lbs and above in K(ilo)lbs.
- Maximum load cell divisions.
- Load Cell model.

Dimensions in mm

Standard version

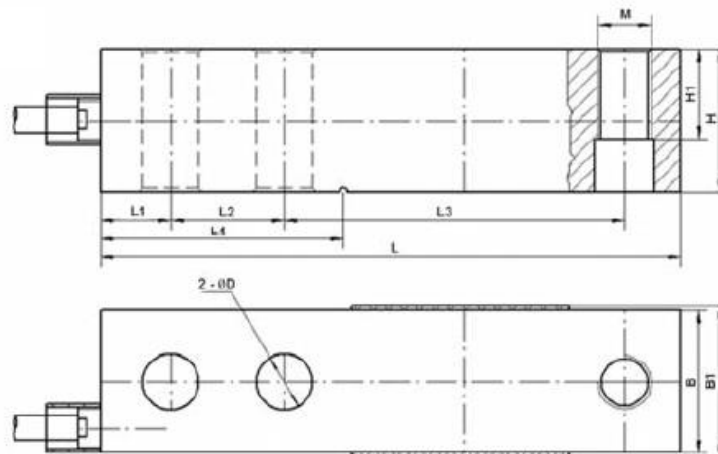

Option W4 version (Through loading hole)

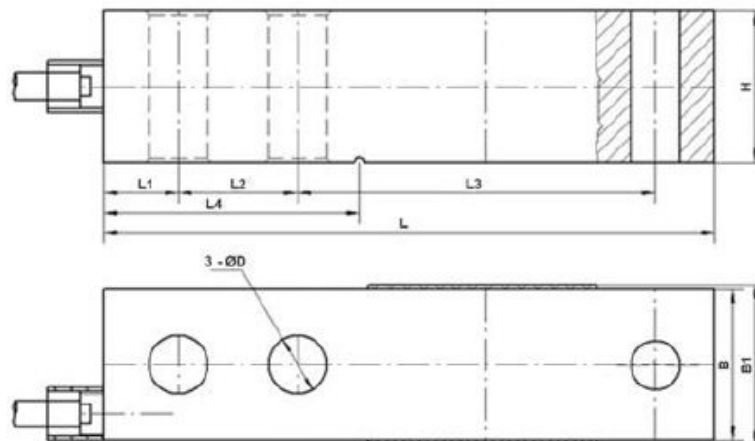

Specifications and dimensions are subject to change without notice and do not constitute any liability whatsoever.

Type H8C Load Cell

Option W6 version ("T" end loading hole)

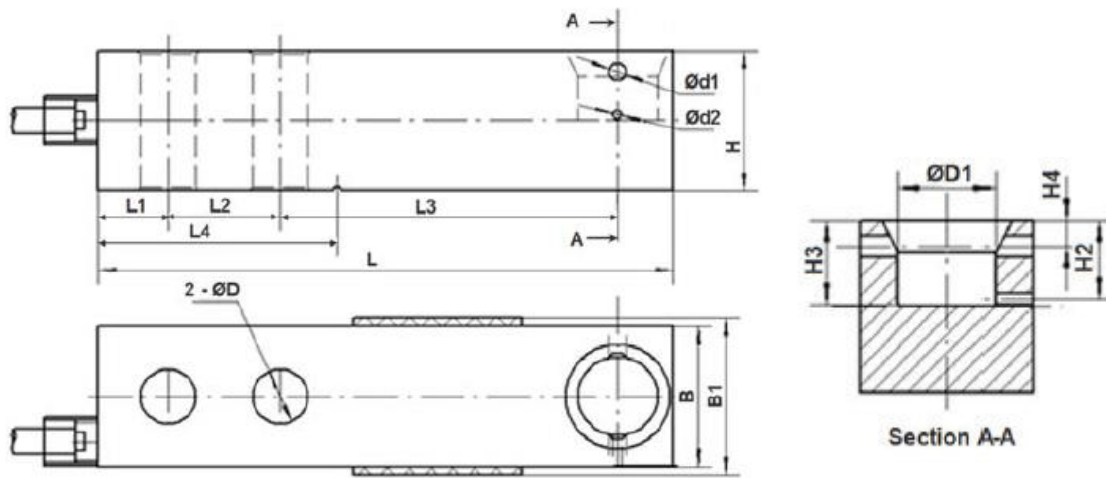

Dimension Capacity	L	L1	L2	L3	L4	B	B1	H	H1	H2	H3	H4	ØD	Ø D 1	Ø d 1	Ø d 2	M
100kg - 250kg	130	15.8	25.4	76.2	54.2	31.8	37	31.8	15.8	14.5	15.8	4.8	13.5	18	4	2	M 12 x 1.75
0.5t-2t	130	15.8	25.4	76.2	54.2	31.8	34	31.8	15.8	14.5	15.8	4.8	13.5	18	4	2	M 12 x 1.75
2.5t-5t	171.5	19.1	38.1	95.3	77.2	38.1	40	38.1	18.8	17.5	18.8	4.8	19.8	25	4	2	M 18 x 1.5
10t	222.3	25.4	50.8	120.7	101.6	50.8	52.4	50.8	25.4	-	-	-	26	-	-	-	M 24 x 2

Specifications and dimensions are subject to change without notice and do not constitute any liability whatsoever.

Type H8C Load Cell

Available accessories

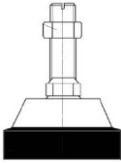
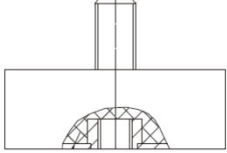
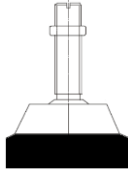
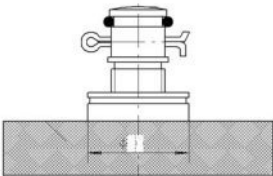
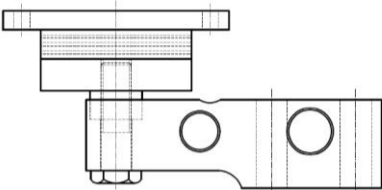
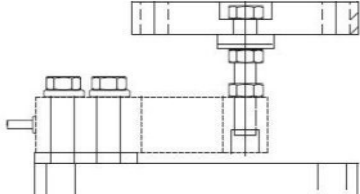
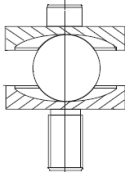
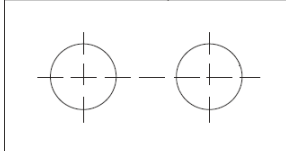
<p>HJ-8-201-0.1-10t foot</p> <ul style="list-style-type: none"> • $\varnothing 60-86$ and height 92-112 mm • Nickel plated alloy steel • Adjustable height 	
<p>HJ-8-203-0.1-2t foot</p> <ul style="list-style-type: none"> • $\varnothing 67$ and height 46 mm • Nickel plated alloy steel • Easy installation 	
<p>HJ-8-213-0.5-2t foot</p> <ul style="list-style-type: none"> • $\varnothing 60$ and height 62 mm • Nickel plated alloy steel • Adjustable height 	
<p>HJ-8-236-0.25-5t foot</p> <ul style="list-style-type: none"> • $\varnothing 80$ and height 50 mm • Nickel plated alloy steel • Adjustable mount • Easy installation 	
<p>Elastomer-0.5-10t</p> <ul style="list-style-type: none"> • Easy installation • Suitable for shock load 	
<p>HM-8-402-0.5-5t mount</p> <ul style="list-style-type: none"> • Nickel plated alloy steel • Adjustable mounting height • Easy installation 	
<p>HY-8-102-0.5-5t</p> <ul style="list-style-type: none"> • Nickel plated alloy steel • Easy installation • Good self-alignment ability 	
<p>HD-8-301-0.5-5t spacer plate</p> <ul style="list-style-type: none"> • Nickel plated alloy Steel 	

Specifications and dimensions are subject to change without notice and do not constitute any liability whatsoever.